

G40KT/G50KT/G60KT

Grid-Connected Inverter *Installation and Operation Manual*

Contents

1. Introduction	3
1.1 Product Description	3
1.2 Unpacking inspection.....	4
1.3 Packaging	4
1.4 Optional Packaging	5
1.5 Inverter Storage	6
2. Safety Instructions	7
2.1 Safety Symbols	7
2.2 General Safety Instructions	7
2.3 Notice For Use.....	8
3. Overview	9
3.1 Front Panel Display	9
3.2 LED Status Indicator Lights	9
3.3 Keypad	10
3.4 LCD	10
4. Installation	11
4.1 Select Location for the Inverter	11
4.2 Mounting the Inverter.....	13
4.3 Electrical Connections	15
4.3.1 Connect PV side of inverter	15
4.3.2 Connect grid side of inverter	18
4.3.3 External ground connection	20
4.3.4 Max. overcurrent protection device (OCPD).....	21
4.3.5 Inverter monitoring connection	22
4.3.6 CT connections (optional)	23
4.3.7 DRED port connections(optional).....	27
5. Start & Stop	28
5.1 Start the Inverter	28
5.2 Stop the Inverter	28

Contents

- 6.LCD Operation Menu..... 29
 - 6.1 Initialization.....29
 - 6.2 Major cycle menuon29
 - 6.3 User interface.....31
 - 6.4 Setting.....31
 - 6.5 Inquiry.....40
 - 6.6 Statistics.....42
- 7.Maintenance 44
- 8.Trouble shooting 45
- 9.Specifications 48
- 10.Quality Assurance 54
- 11.Contact Informaiton 55

01 Introduction

1.1 Product Description

The new generation of household three-phase series photovoltaic grid connected inverter converts the sun into electric energy through the inverter device, which is used by the power users. It adopts a new design and integrates various functional devices to adapt to various complex installation environments.

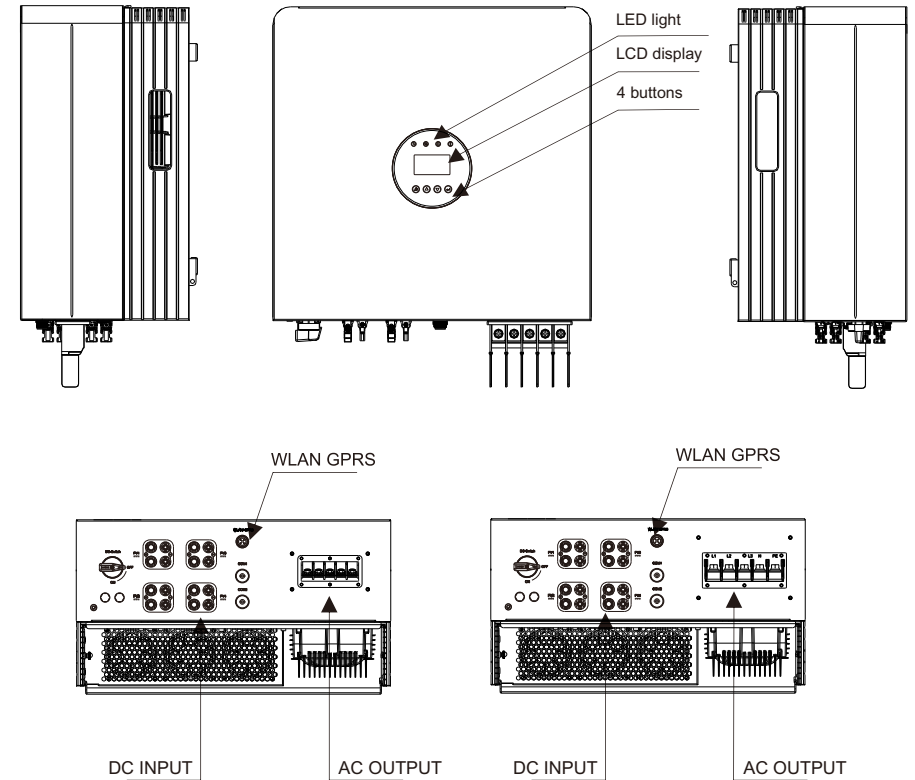

▲ Figure 1 Bottom side view

Object	Description	DVC class	Object	Description	DVC class
1	PV	DVC C	2	COM1(CT)	DVC A
3	WLAN GPRS	DVC A	4	AC	DVC A

1.2 Unpacking Inspection

Before opening the inverter package, please check whether the outer package is damaged.

After opening the package, please check whether the inverter appearance is damaged or lack of accessories. The placement of accessories is as follows:

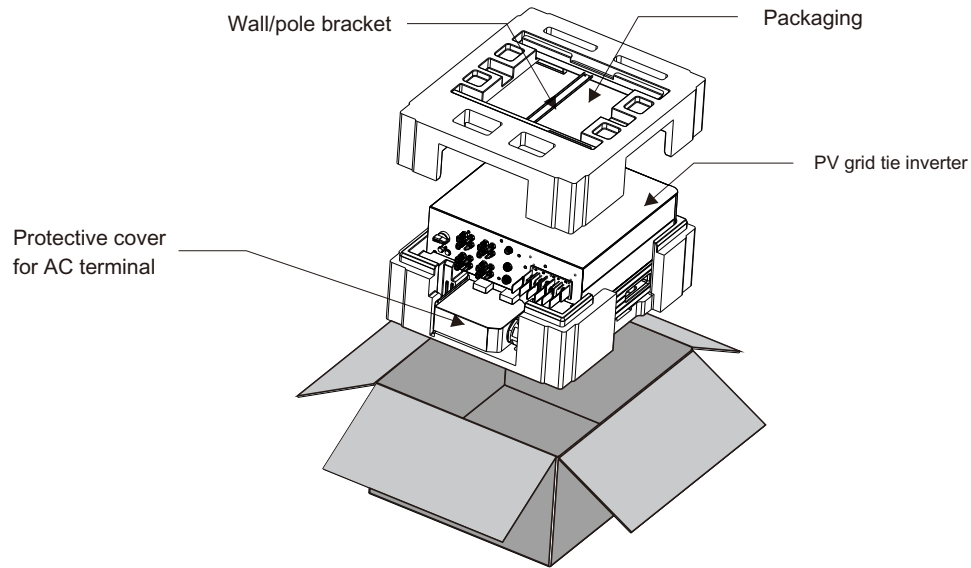

1.3 Packaging

When you receive the inverter, ensure that all the parts listed below are included:

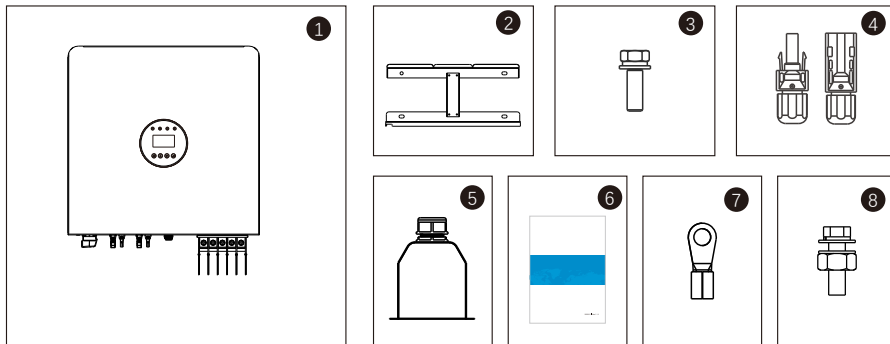

Part #	Description	Model	Number
1	PV grid tie inverter		1
2	Wall/pole bracket		1
3	Locking screws		6
4	PV connection terminal (+,-)	40K	6
		50~60K	8
5	Protective cover for AC terminal		1
6	Manual		1
7	OT terminal		6
8	Combination screw		4

1.4 Optional Packaging

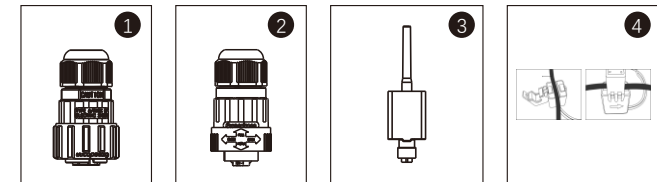

Part #	Description	Number
1	DRM connector	1
2	Meter 485 connector	1
3	WiFi/GPRS Stick	1
4	1xCT and com cable	1

1.5 Inverter Storage

Proper storage is required if the inverter is not installed immediately.

- Store the inverter in the original packing case.
- The storage temperature must be always between -40°C and $+70^{\circ}\text{C}$, and the storage relative humidity must be always between 0 and 95%, non-condensing.
- In case of stacking storage, the number of stacking layers should never exceed the limit marked on the outer side of the packing case.

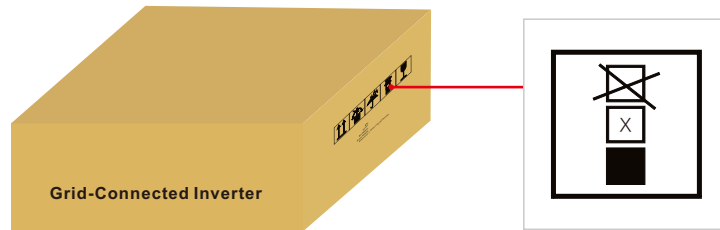

- The packing case should be upright.
- If the inverter has been stored more than half a year, the qualified personnel should thoroughly check and test it before using.

02 Safety Instructions

Improper use may result in potential electric shock hazards or burns. This manual contains important instructions that should be followed during installation and maintenance. Please read these instructions carefully before use and keep them for future reference.

Contact the nearest hazardous waste disposal station when the products or components are discarded.

2.1 Safety Symbols

Safety symbols used in this manual, which highlight potential safety risks and important safety information, are listed as follows:



WARNING:

WARNING symbol indicates important safety instructions, which if not correctly followed, could result in serious injury or death.



NOTE:

NOTE symbol indicates important safety instructions, which if not correctly followed, could result in some damage or the destruction of the inverter.



CAUTION:

CAUTION, RISK OF ELECTRIC SHOCK symbol indicates important safety instructions, which if not correctly followed, could result in electric shock.



CAUTION:

CAUTION, HOT SURFACE symbol indicates safety instructions, which if not correctly followed, could result in burns.

2.2 General Safety Instructions



WARNING:

Only devices in compliance with SELV may be connected to the RS485 and USB interfaces.



WARNING:

Please don't connect PV array positive(+) or negative(-) to ground, it could cause serious damage to the inverter.



WARNING:

Electrical installations must be done in accordance with the local and national electrical safety standards.



WARNING:

Do not touch any inner live parts until 5 minutes after disconnection from the utility grid and the PV input.

WARNING:



To reduce the risk of fire, over-current protective devices (OCPD) are required for circuits connected to the Inverter. The DC OCPD shall be installed per local requirements. All photovoltaic source and output circuit conductors shall have disconnects that comply with the NEC Article 690, Part II.

CAUTION:



Risk of electric shock. Do not remove cover. There is no user serviceable parts inside. Refer servicing to qualified and accredited service technicians.

CAUTION:



The PV array (Solar panels) supplies a DC voltage when they are exposed to sunlight.

CAUTION:



Risk of electric shock from energy stored in capacitors of the Inverter. Do not remove cover for 5 minutes after disconnecting all power sources(service technician only). Warranty may be voided if the cover is removed without unauthorized. If the equipment is used in a manner not specified by the manufacturer, the protection provided by the equipment may be impaired.

CAUTION:



The surface temperature of the inverter can reach up to 75°C (167 F). To avoid risk of burns, do not touch the surface of the inverter while it's operating. Inverter must be installed out of the reach of children.



PV module used with inverter must have an IEC 61730 Class A rating.

CAUTION:



If the machine is configured with PID function, the panel is charged at night.

2.3 Notice For Use

The inverter has been constructed according to the applicable safety and technical guidelines. Use the inverter in installations that meet the following specifications ONLY:

1. Permanent installation is required.
2. The electrical installation must meet all the applicable regulations and standards.
3. The inverter must be installed according to the instructions stated in this manual.
4. The inverter must be installed according to the correct technical specifications.
5. To startup the inverter, the Grid Supply Main Switch (AC) must be switched on, before the solar panel's DC isolator shall be switched on. To stop the inverter, the Grid Supply Main Switch (AC) must be switched off before the solar panel's DC isolator shall be switched off.
6. The machine damage caused by the burst grounding fault of the inverter during grid-connected operation is not covered by the warranty.

03 Over view

3.1 Front Panel Display

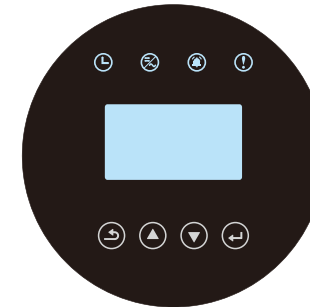

▲ Figure 3.1 Front Panel Display

3.2 LED Status Indicator Light

The LED status indicator can display red and green. When the indicator light is on, it indicates that there is power. When the indicator light is red, it indicates the alarm state; when the indicator light is green, it indicates the operation state.

Light	Status	Description
	ON	Checking: The device is checking.
	ON	Generating: The device is generating the power.
	twinkle	Generating: flashing indicates that the inverter is being connected to the power grid.
	twinkle	Alarm: the inverter has an alarm signal.
	ON	Fault: A fault occurs and the device is not generating.

▲ Table 3.1 status indicator

3.3 Keypad

There are four keys in the front panel of the Inverter from left to right: ESC, UP, DOWN and ENTER keys. The keypad is used for:

- Scrolling through the displayed options (the UP and DOWN keys);
- Access to modify the adjustable settings (the ESC and ENTER keys).

3.4 LCD

The four-line Liquid Crystal Display (LCD) is located on the front panel of the Inverter, which shows the following information:

- Inverter operation status and data;
- Service messages for operator;
- Alarm messages and fault indications.

You can also get information via WiFi / GPRS.

04 Installation

4.1 Select a Location for the Inverter

To select a location for the inverter, the following criteria should be considered:

- Do not install in small closed spaces where air can not circulate freely. To avoid over heating, always make sure the flow of air around the inverter is not blocked.
- Exposure to direct sunlight will increase the operational temperature of the inverter and may cause output power limiting. Kstar recommends inverter installed to avoid direct sunlight or raining.
- To avoid overheating ambient air temperature must be considered when choosing the inverter installation location. Kstar recommends using a sun shade minimizing direct sunlight when the ambient air temperature around the unit exceeds 104°F/40°C.

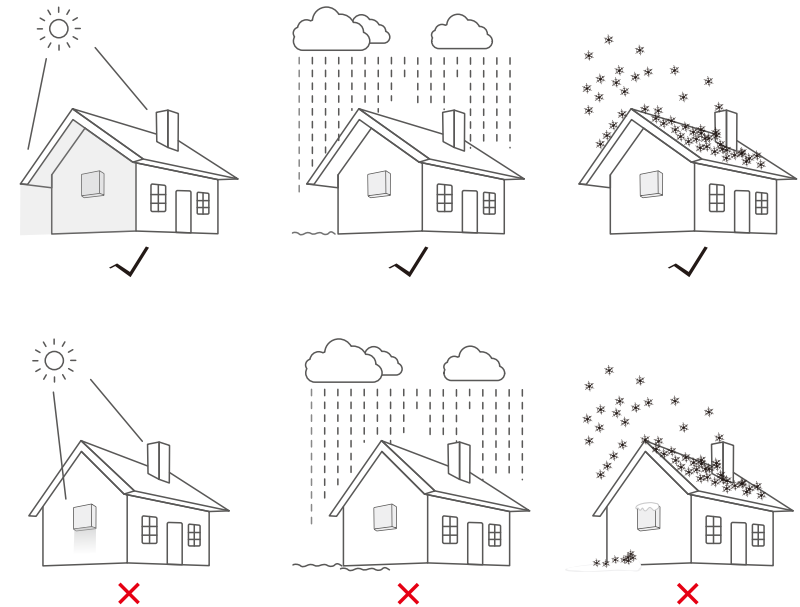

▲ Figure 4.1 Recommended Installation locations

- Install on a wall or strong structure capable of bearing the weight.
- Install vertically with a maximum incline of $\pm 5^\circ$. If the mounted inverter is tilted to an angle greater than the maximum noted, heat dissipation can be inhibited, and may result in less than expected output power.
- When 1 or more inverters are installed in one location, a minimum 500mm clearance should be kept between each inverter or other object (if a canopy is added, a distance of 500mm must also be kept, it is necessary to install the canopy first and then fix the inverter to avoid the blocking of the fan caused by the cement debris falling during drilling). The bottom of the inverter should be 800mm clearance to the ground.

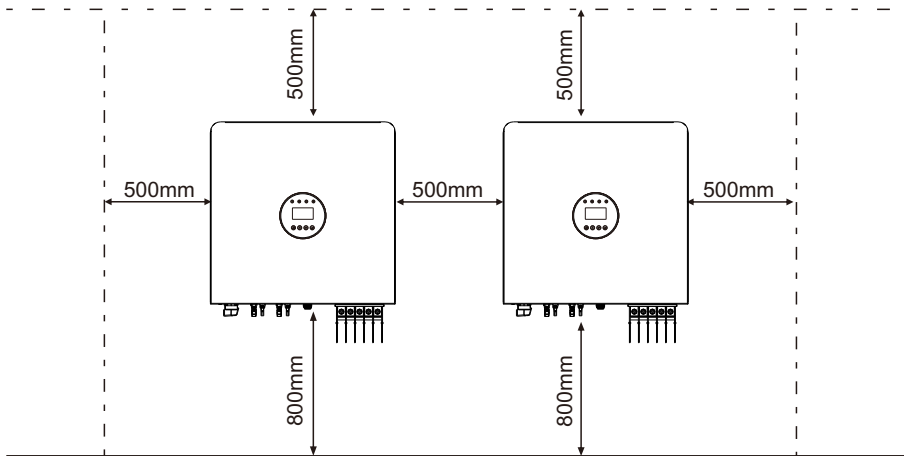

▲ Figure 4.2 Inverter Mounting clearance

- Visibility of the LED status indicator lights and the LCD located at the front panel of the inverter should be considered.
- Adequate ventilation must be provided if the inverter is to be installed in a confined space.



NOTE:

Nothing should be stored on or placed against the inverter. It is not allowed to lay the machine horizontally for a long time, which will affect the heat dissipation.

4.2 Mounting the Inverter

Dimensions of wall bracket:

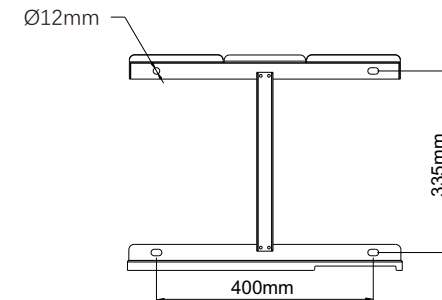

▲ Figure 4.3 Inverter wall mounting

The inverter shall be mounted vertically. The steps to mount the inverter are listed below:
 1. According to Figure 4.2, select the bracket mounting height.
 The inverter standard with bolt group (including nut, flat gasket, spring washer) before delivery. To make the inverter can be installed to various metal holder. Use Ø12 driller kit to drill installation holes on the metal holder according to the hole position of the rack. Then fix the rack to metal holder by using bolt group.

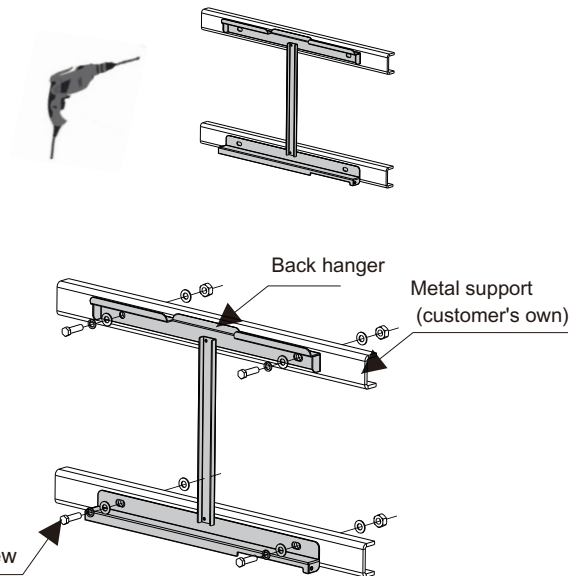

▲ Figure 4.4 Inverter wall mounting

2. Lift the inverter to the mounting plate and ensure that the mounting ears fit well with the grooves of the mounting plate. Check the sides to make sure they are in place.



WARNING:

The inverter must be mounted vertically.



NOTE:

In the process of machine handling, the bottom of the left and right plastic decorative parts should not be stressed to avoid damage to personnel and machinery caused by damage to plastic parts.

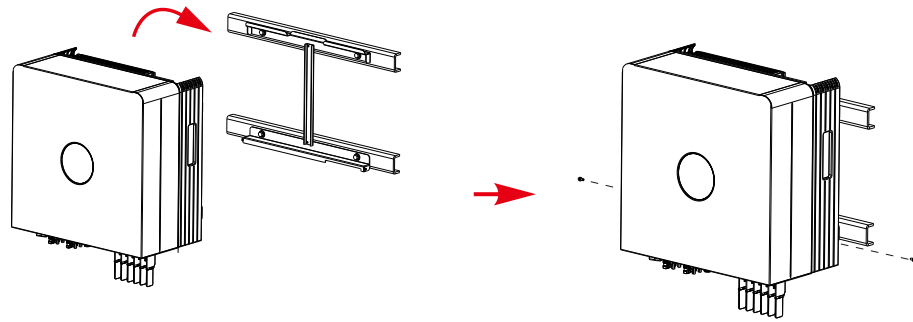
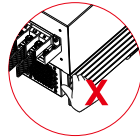

▲ Figure 4.5 Wall Mount Bracket

3. Use M4 screws in accessory to lock the inverter to the mount bracket.

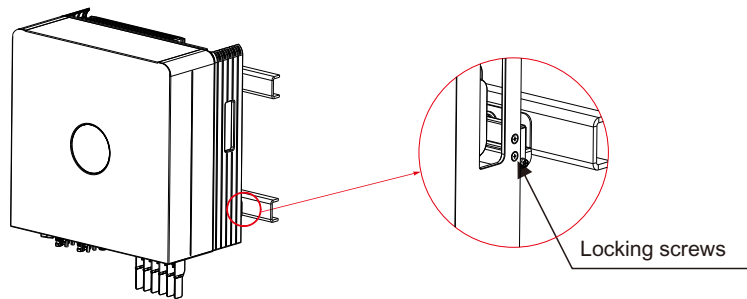

Locking screws

4.3 Electrical Connections

4.3.1 Connect PV side of inverter

The electrical connection of the inverter must follow the steps listed below:

1. Switch the Grid Supply Main Switch (AC) OFF.
2. Switch the DC Isolator OFF.
3. Assemble PV input connector to the Inverter.



Check whether the polarity of the connecting cable of the photovoltaic string is correct, and ensure that the open circuit voltage under any condition does not exceed the upper limit of the inverter input value of 1100V.



Please don't connect PV array positive or negative pole to the ground, it could cause serious damages to the inverter.



Before connection, please make sure the polarity of the output voltage of PV array matches the "PV+" and "PV-" symbols.

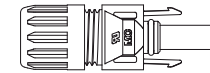

▲ Figure 4.6 PV+ Connector

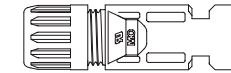

▲ Figure 4.7 PV- Connector

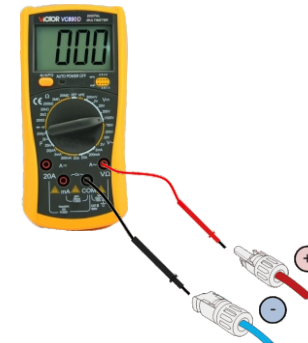

Check the positive and negative polarity of the PV strings, and connect the PV connectors to the right terminals. Serious damages to the inverter and connector over temperature may occur.

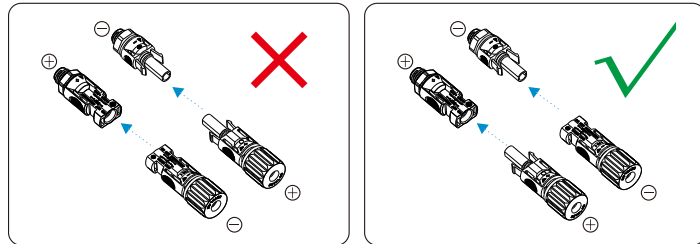

Please use approved DC cable for PV system.

Cable type	Cross section	
	Range	Recommended value
Industry generic PV cable(model:PV1-F)	4.0-6.0 (12-10AWG)	4.0 (12AWG)

▲ Table 4.1 DC cable

The steps to assemble the DC connectors are listed as follows:

1. Strip off the DC wire for about 7mm, Disassemble the connector cap nut.

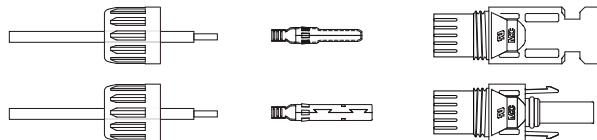

▲ Figure 4.8 Disassemble the Connector Cap nut

2. Insert the wire into the connector cap nut and contact pin.

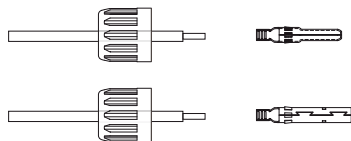

▲ Figure 4.9 Insert the Wire into the Connector Cap nut and contact pin

3. Crimp the contact pin to the wire using a proper wire crimper.

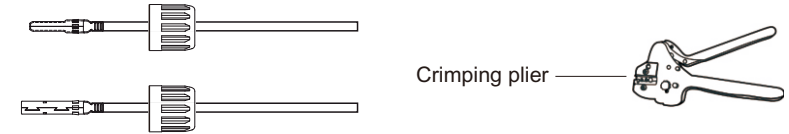

▲ Figure 4.10 Crimp the contact pin to the wire

4. Insert the contact pin to the top part of the connector and screw up the cap nut to the top part of the connector.

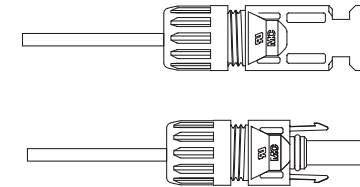

▲ Figure 4.11 Connector with Cap nut Screwed on

5. Then connect the DC connectors to the inverter. Small click will confirm connection.

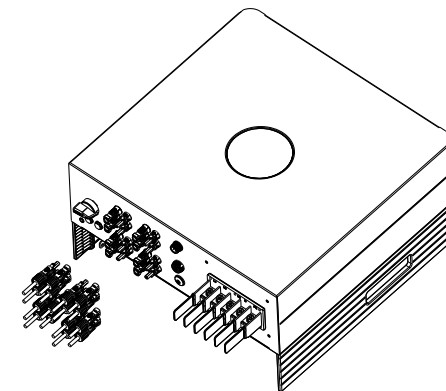

▲ Figure 4.12 Connect the DC Connectors to the Inverter

4.3.2 Connection of AC output

WARNING:



There are "L1,L2,L3" "N" "PE" symbols marked inside the connector, the Line wire of grid must be connected to "L1,L2,L3" terminal; the Neutral wire of grid must be connected to "N" terminal; the Earth of grid must be connected to "PE"

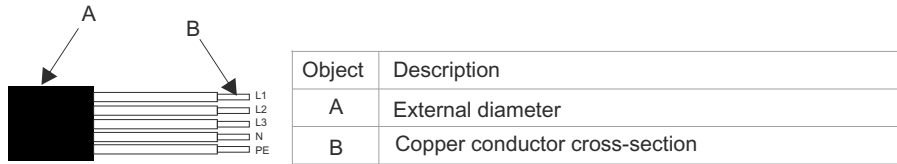

Model	Cable outer diameter range	Cross section Range	Recommended cable section wire diameter
40K	φ20~φ28mm	16-25mm ²	25 mm ²
50K~60K	φ24~φ44mm	25-70mm ²	35 mm ²

▲ Table 4.2 AC cable

Connect grid side of inverter

1. First check the AC circuit breaker and disconnect the inverter and the grid
2. Use wire stripper to peel the outer surface of the cable for about 50 mm, and then peel off the wire skin of 5 wires, as shown in the figure below;

Step 1. Strip the protection layer and insulation layer by specific length,as described in the figure below.

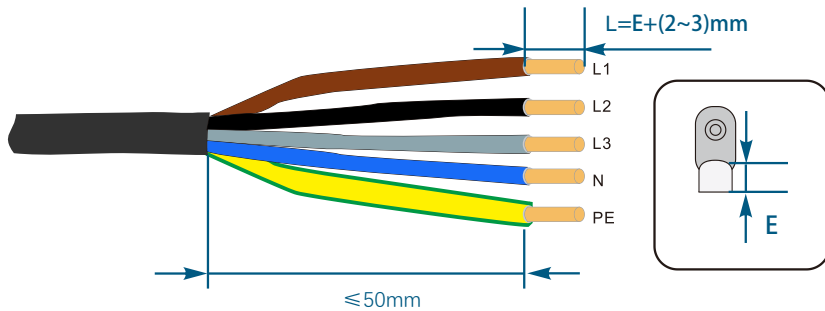

Step 2. Make the cable and crimp the OT terminal.

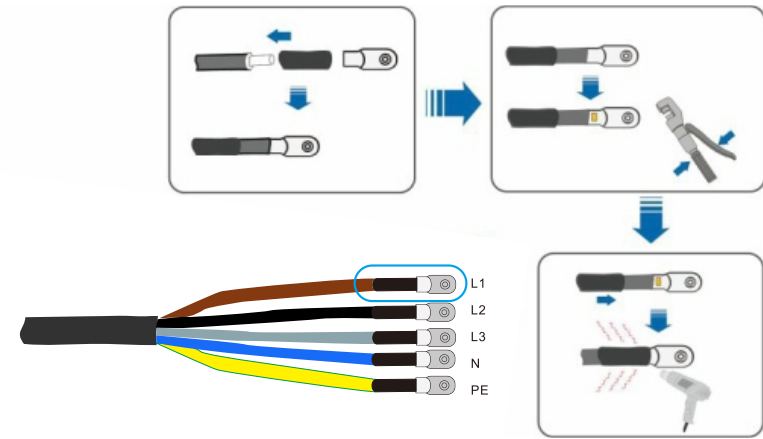

Step 3. Follow the instruction and secure the cable to corresponding terminals.

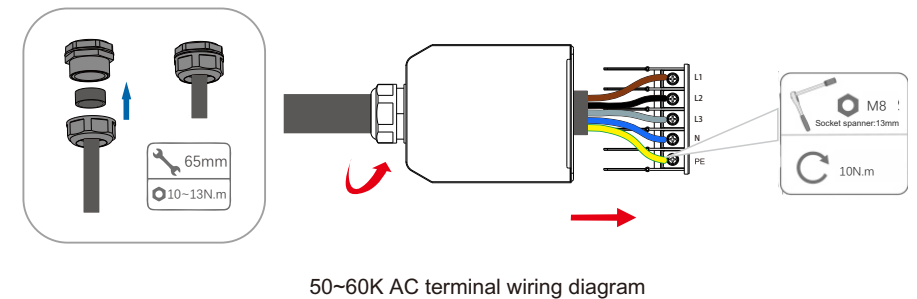
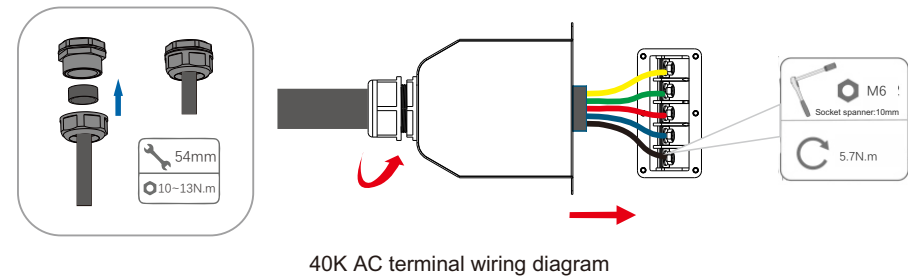

Step 4. Secure the junction box,fasten the buckle, and secure it with screw.

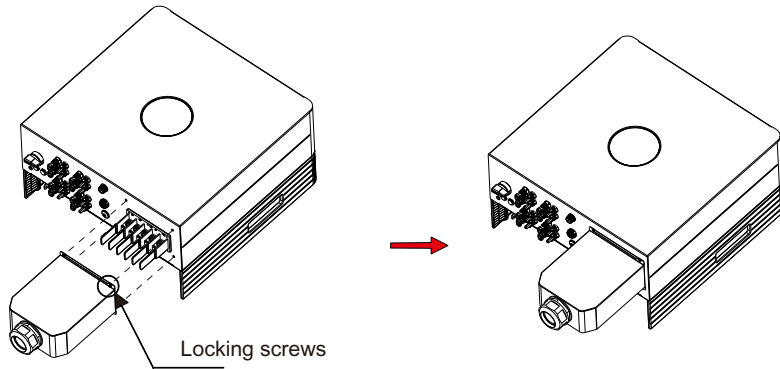

▲ Figure 4.13 Connect the AC Connector to the Inverter

4.3.3 External ground connection

The external ground connection is located on the bottom side of the inverter. Prepare OT terminal, tighten the screw. The machine comes with it. Use appropriate tools to screw out the screw and crimp the lug to the terminal.

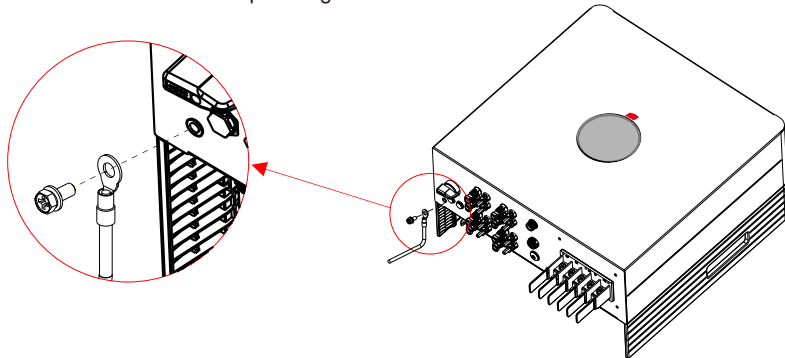

▲ Figure 4.14 Connect the external grounding conductor



Note:

When earth fault occurs, the machine cannot be connected to the grid, the LED red light is on, and the LCD displays the fault code F07 until the fault is resolved.

4.3.4 Max, over current protection device (OCPD)

To protect the inverter's PV and AC grid connection conductors, Kstar recommends installing breakers that will protect against overcurrent. The following table defines OCPD ratings for the inverters.

Inverter	Rated output voltage(V)	Rated output current (A)	Current for protection device (A)
G40KT6	400	57.7	80
G50KT6	400	72.2	100
G60KT6	400	86.6	125

▲ Table 4.3 OCPD level of power grid

Inverter	Rated input voltage(V)	Max. input current (A)	Current for protection device (A)
G40KT6	650	32/32/20/20	60
G50KT6	650	40/40/32/32	80
G60KT6	650	40/40/32/32	80

▲ Table 4.4 PV OCPD ratings

4.3.5 Inverter monitoring connection

The inverter can be monitored via Wi-Fi or GPRS. All communication devices are optional. For connection instructions, please refer to the Monitoring Device installation manuals.

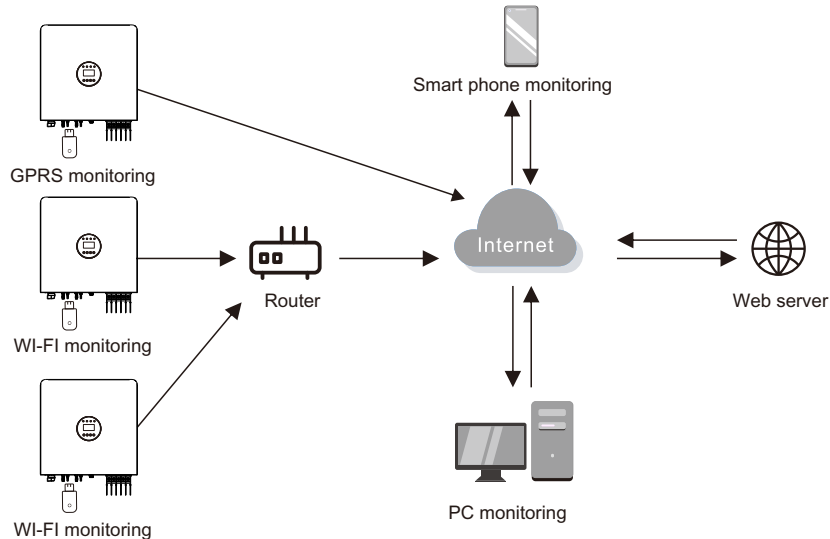

▲ Figure 4.15 Communication function

The inverter is equipped with standard RS485 and WLAN/GPRS communication ports, and the RS485 communication port is mainly used for the software upgrade, WLAN/GPRS communication port is for inverter wireless monitoring.

Pin	Description	Pin	Description
1	VCC	3	485A
2	GND	4	485B

▲ Table 4.5

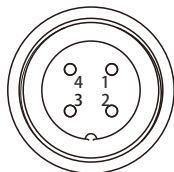

▲ Figure 4.16 Inverter WLAN/GPRS port

4.3.6 Meter connections (optional)

1. Explanation of Anti-Backflow Function

To meet on-site requirements, the inverter output power is controlled to adjust according to the load power, ensuring that the inverter output power is primarily utilized by the load. The total power fed into the grid is restricted to either 0 or within a predefined power limit. The direction of the anti-backflow meter's CT (Current Transformer) is defined as positive when pointing towards the load. A positive power reading on the meter indicates power consumption from the grid, while a negative power reading indicates power generation to the grid, resulting in backflow.

2. System wiring diagram

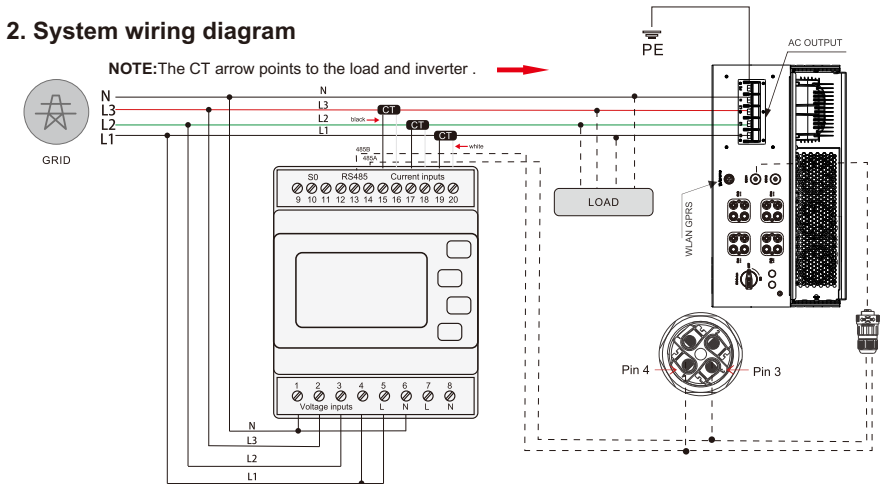

▲ Figure 4.17 Schematic diagram of connection between inverter and meter (Inverter on the right side of load)

1. The direction of the current transformers (CTs) must remain consistent, oriented from the grid towards the electrical load and inverter.
2. The current transformers and voltage phase sampling must correspond one-to-one, and the black and white connections of the transformers must be consistent.
3. The installation location of the current transformer (CT) must be at the point where the power load converges with the inverter and is connected to the grid.
4. The current transformers supplied with the meter are only compatible with cables of 35 mm² or less in onsite applications.



3. Meter Installation

- ①. The anti-backflow meter needs to be installed inside the distribution box.
- ②. Open the locking clip at the bottom of the meter and mount the meter onto the rail.
- ③. Current Transformer Installation. The provided current transformer is only compatible with cables with a cross-sectional area of 35 mm² or less. If the cable size exceeds this limit, the meter model must be replaced. The current transformer's direction is oriented from the grid to the load and the inverter. Connect S1 to the white wire and S2 to the black wire.

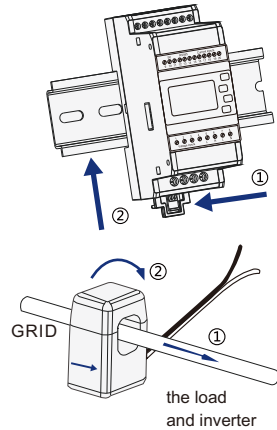

4. Installation of Communication Cable between Inverter and Meter:

- ①. Pin 3 of the connector is 485+, and Pin 4 is 485-.
- ②. Connect 485+ to terminal 14 of the meter and 485- to terminal 13 of the meter.

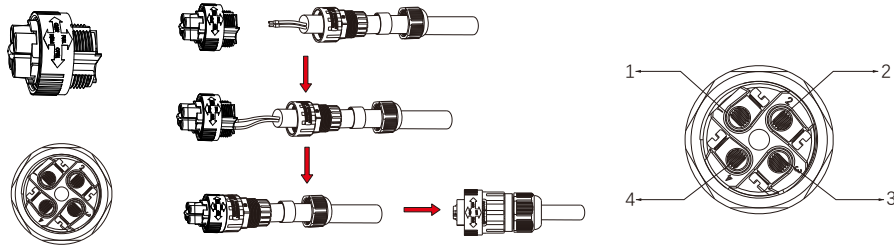

▲ Figure 4.18 CT connector

5. Anti-backflow meter wiring verification

- ①. Disconnect the inverter's grid connection switch. With a load connected, briefly press the "P" button to check the power on the meter. The first page shows the power for L1, L2, and L3. If the power is positive, it indicates power is being drawn from the grid. If the power is negative, it indicates the current transformer is installed incorrectly.
- ②. Press the "U/I" button. The first page shows the grid phase voltage, the second page shows the grid line voltage, and the third page shows the current sampling. To verify L1 wiring, multiply the L1 phase voltage by the L1 current sampling value to get the L1 power value. For example, if the L1 voltage is 230V and the L1 current is 10A, the L1 power should be 2.3kW, indicating that the L1 wiring is correct.
- ③. Similarly, verify L2 and L3. If the values are incorrect, it may indicate a mismatch between the voltage and current transformers.

6. Inverter anti-backflow function setting:

```

-----USER-----
->1:SETUP
   2:INQUIRE
   3:STATISTIC
    
```

Step 1: Press Return button to enter user setting interface. Then select the "1.SETUP" menu item and confirm your selection with the Enter button. (Press Up button or down button to select different options)

```

-----PASSWORD-----
INPUT : XXXXX
    
```

Step 1(2): Before entering the setup interface, enter the password "00000" and confirm the entry by pressing the Enter button. (Press Up button or down button to change the number, and press Enter button to input the next number)

```

-----SETUP-----
  2: GRID STD
  3: REMOTE CTRL
->4: RUN SETTING
    
```

Step 2: Press Down button to find the option "4: RUN SETTING" and confirm the entry by pressing the Enter button.

```

--RUN SETTING--
->16: Anti Rev-I
   1: VPN-START
   3: DELAY-START
    
```

Step 3: Press Down button to find the option "16: Anti Rev-I" and confirm the entry by pressing the Enter button.

```

Anti Rev-Current
->1: Enab/Disab
   2: Meter type
   3: Anti Method
    
```

Step 4: After entering "Anti Rev-I", press Down button to find the option "1: Enab/Disab" and confirm the entry by pressing the Enter button. Change the settings to Enable or Disable as required. Note that the "meter type" in step 5 can not be changed if this setting is "Enabled".

```

--Meter Type--
->1: ACREL
   2: ESTRON
   3: EYBOND
    
```

Step 5: Press Down button to find the option "2: Meter type" and confirm the entry by pressing the Enter button. Select the correct meter type "Acrel" or "Estron". The meter type is screen printed on the meter. If the "meter type" needs to be changed, please make sure the "Anti Rev-I" function is "Disabled".

```

Anti R-I Method
->1: SinglePhase
   2: R-S-T Sum
    
```

Step 6: Press Return button to "Anti-Rev Current" interface and press Down button to find the option "3: Anti Method" and confirm the entry by pressing the Enter button. Select the required method.

Single Phase: Adjust the inverter's output based on the phase that has the lowest output and ensure there is no export power on the phase level.

R-S-T Sum: Adjust the inverter's output according to all three phases' output and ensure there is no export power on the system level.

```

Amended Value
INPUT: +0000
UNIT: W
Range: +/-32767
    
```

Step 7: Press Return button to "Anti-Rev Current" interface and press Down button to find the option "4: Anti Amend" and confirm the entry by pressing the Enter button. Set the required Amended value.

7. Grid Connection Verification:

- ①. When the inverter is connected to the grid and there is load power, if the inverter's power gradually decreases to 0%, it indicates a communication issue between the inverter and the meter. In this case, check whether the communication line connector is properly connected.
- ②. After the inverter is connected to the grid, check the "P" value on the meter. If the sum of the values for L1, L2, and L3 on page 1 shows a significant negative power, it indicates reverse power flow, which is abnormal. If the value is greater than 0 and the inverter is outputting power normally, the system is functioning properly.

8. Anti-backflow method:

single-phase power control:

- The control is based on the power of each phase. When any phase experiences backflow power generation, the inverter will adjust its output based on the minimum phase power to ensure that no phase feeds power back into the grid.
- The inverter output is three-phase balanced, and the power flow is as shown in the diagram below. Assuming the load power is 10kW/20kW/30kW, the inverter outputs 10kW per phase. The grid power in phase L1 is 0kW, L2 draws 10kW, and L3 draws 20kW.

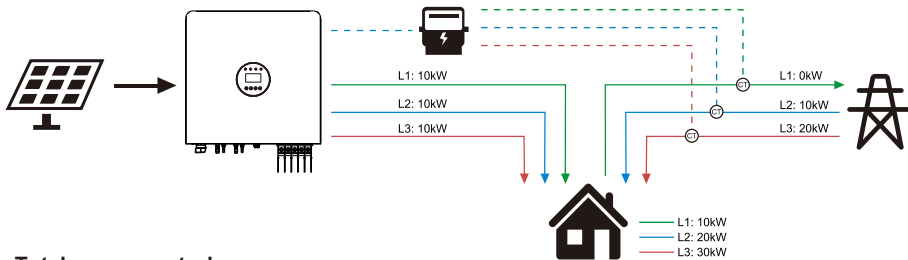

Total power control:

- Control according to the total power, individual phases may experience backfeed, but the overall grid power will be maintained without backfeed.
- The power flow is as shown in the diagram below. The load power is 10kW/30kW/20kW, and the inverter outputs 20kW per phase. The grid power for L1 backfeeds 10kW, L2 draws 10kW, and L3 power is 0.

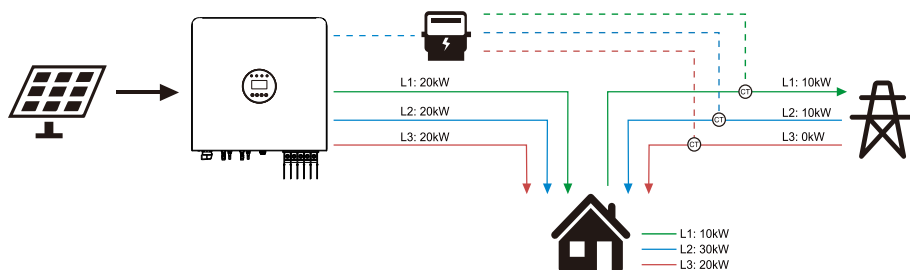

9. Anti-backflow power setting:

- When the inverter is paired with a power meter, it supports the anti-backflow power setting (backflow power calibration value). As shown in the example below, under sufficient sunlight conditions, when the backflow power calibration value is set to 0, the inverter power limit is 60KW. If the setting is adjusted to +5KW, the inverter power limit increases to 65KW.
- The backflow power calibration value defines the maximum power that can be fed back to the grid. When set to 0, the allowed feed-in power per phase is 0KW. When set to +5KW, the total power allowed to be fed back to the grid is 5KW.

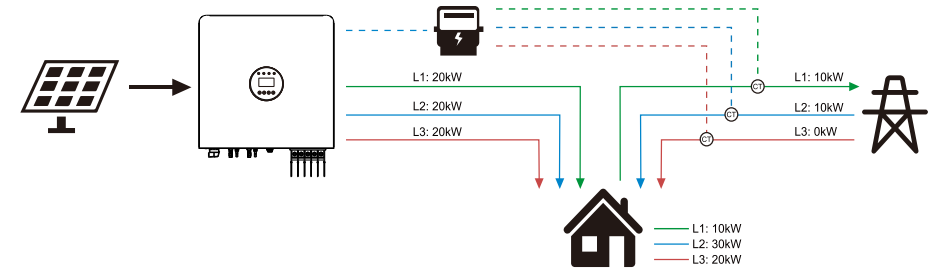

4.3.7 DRED port connections(optional)

DRED means demand response enable device. The AS/NZS 4777.2:2015 required inverter need to support demand response mode(DRM). This function is for inverter that comply with AS/NZS 4777.2:2015 standard. Inverter is fully comply with all DRM. A 6P terminal is used for DRM connection.

Table 4.7

Pin	Description	Default value
PIN1-PIN6	Shutdown	Shutdown
PIN2-PIN6	Power limitation 0%	Power limitation 0%
PIN3-PIN6	Power limitation 50%	Power limitation 50%
PIN4-PIN6	Power limitation 75%	Power limitation 75%
PIN5-PIN6	Power recovery 1%/4s	Power recovery 1%/4s

Please follow below figure to assemble DRM connector.

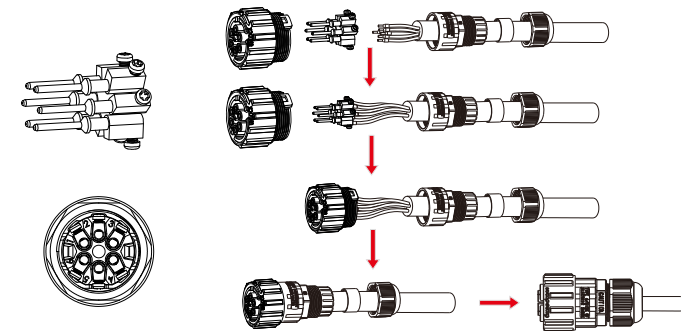

Figure 4.19 DRM connector

05 Start&Stop

5.1 Start the Inverter

To start up the Inverter, it is important that the following steps are strictly followed:

1. Switch the grid supply main Switch (AC) ON first.
2. Switch the DC switch ON. If the voltage of PV arrays are higher than start up voltage, the inverter will turn on. The LED status indicator will light.
3. When both the DC and the AC sides supply to the inverter, it will be ready to generate power. Initially, the inverter will check both its internal parameters and the parameters of the AC grid, to ensure that they are within the acceptable limits. At the same time, the green LED will flash and the LCD displays the information of INITIALIZING.
4. After 60-300 seconds (depending on local requirement), the inverter will start to generate power. The green LED will be on continually and the LCD displays GENERATING.

WARNING:



When the photovoltaic array is exposed to light, it supplies a DC voltage to the PCE. Do not touch it.
Do not touch the surface when the inverter is operating. It may be hot and cause burns.

5.2 Stop the Inverter

To stop the Inverter, the following steps must be strictly followed:

1. Switch the Supply Main Switch (AC) OFF.
2. Wait 30 seconds. Switch the DC Switch OFF. All the LEDs of the inverter will be off in one minute.

06 LCD Operation Menu

6.1 Initialization

Interface	Explanation
	After starting-up of inverter, LCD will firstly enter this interface, and deliver parameters required by operation of the machine to DSP.

6.2 Major cycle menu-on

After initialization, LCD will enter a major cycle menu to display running information of the inverter in a circulating mode, including 10 interfaces for network voltage, frequency of electric network, etc. Time for automatic switch-over between interfaces is 3 seconds, also the interfaces can be switched manually by pressing UP or DOWN buttons, if you want to fix at a certain interface, press ENTER to lock this interface, after successful locking, a lock icon will occur at upper right corner of this interface, press ENTER button again, this interface will be unlocked, and the menu will continue to display in a circulating mode.

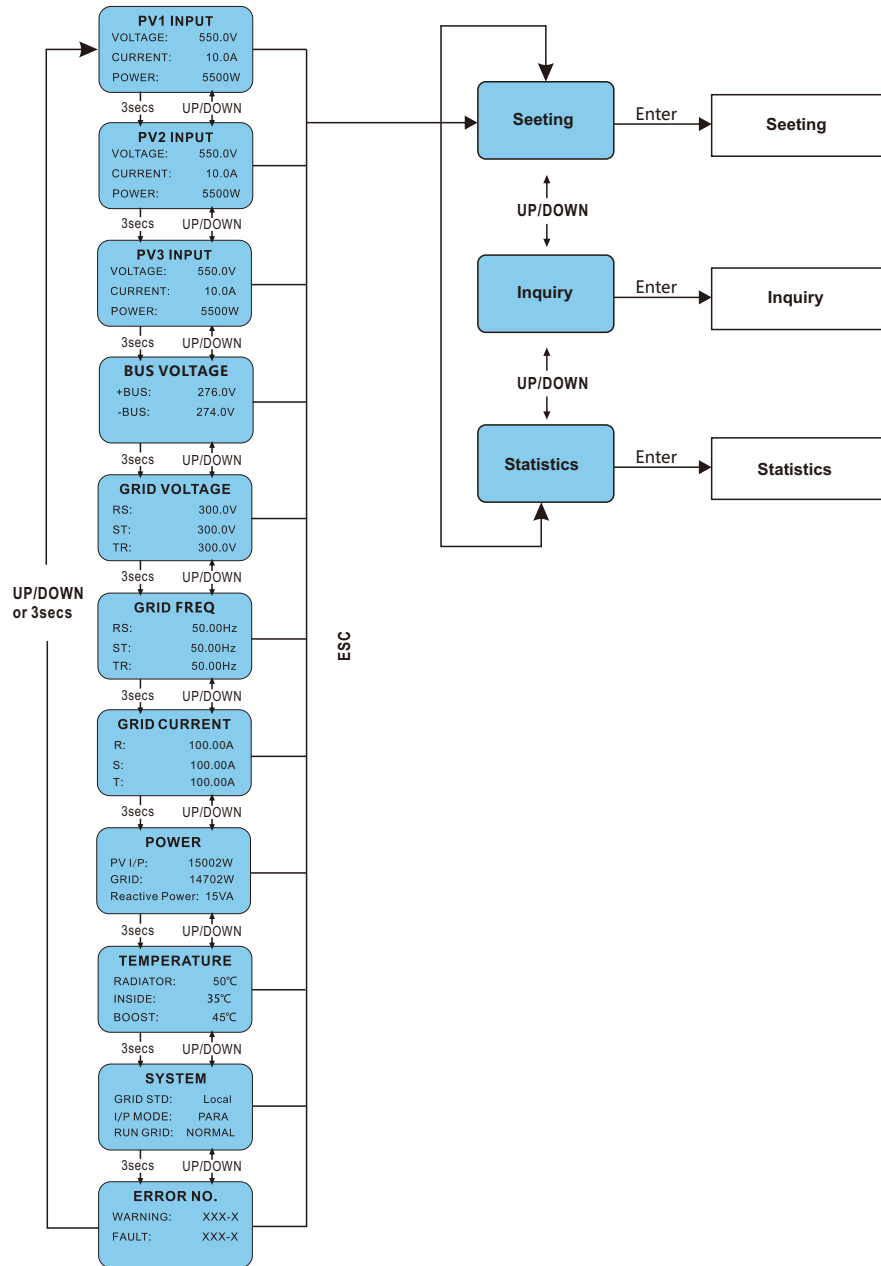

Figure 1: Interface of recycling display

When the menu is in an automatic cycling display mode, if error (fault) or warning alarm occurs, it will skip into system interface immediately and lock to it, and this will make convenience for the user to determine its cause based on codes on the interface. After disappearing of error (fault) or warning alarm, the menu will return to automatic circulating mode. Press ESC button to exit major circulating menu interface and enter user interface (refer to 6.3).

6.3 User interface

Interface	Explanation
<pre> -----USER----- ->1:Setting 2:Inquire 3:Statistics </pre>	Select corresponding options by pressing UP or DOWN button, enter "setting", "inquiry" and "statistics" menus by pressing ENTER button. Press ESC to return major circulating menu.

6.4 Setting

Interface	Explanation
<pre> ---PASSWORD--- Input:XXXXX </pre>	After entering into the setup interface, the system will prompt to input password, the default password is "00000", and this password can be altered Password setting menu (refer to 6.4.12); press UP/DOWN to increase or decrease the input figure, press ENTER button to move the cursor backwards, press ESC button to move the cursor forward.

<pre> -----SETUP----- ->1: INPUT MODE 2: GRID STD 3: REMOTE CTRL </pre>	After successful input of password, it will enter setting option interface. Press UP/DOWN to move corresponding options, and enter the selected menu by pressing ENTER button; press ESC button to return back the user interface (refer to 6.3), there are 15 options in total, including input mode, grid std, remote ctrl, run setting, 485 address, baud rate, protocol, language, backlight, date/time, clear rec, password ,maintenance, fctry reset,array detec.
--	---

6.4.1 Input mode

Interface	Explanation
<pre> --- INPUT MODE --- →1:INDEPENDENT 2:PARALLEL </pre>	<p>Press UP/DOWN button to move corresponding option. Then confirm the selected option and enter interface of please restart (refer to 6.4.4.11) by pressing ENTER button. Press ESC button to cancel choice and return back setup interface (refer to 6.4). Default option is independent.</p>

6.4.2 Standard for electric network

Interface	Explanation
<pre> ----GRID STD---- →1:China 2:Germany 3:Australia 4:Italy 5:Spain 6:U.K. </pre>	<p>Press UP/DOWN button to move corresponding options, including China, Germany, Australia, Italy, Spain, U.K; with 16 kinds in total. Then confirm the selected option and enter interface of please restart (refer to 6.4.4.11) by pressing ENTER button. Press ESC button to cancel choice and return back setup interface (refer to 6.4).</p>

6.4.3 Remote CTRL

Interface	Explanation
<pre> ----REMOTE CTRL ---- →1:DISABLE 2:ENABLE </pre>	<p>Press UP/DOWN button to move corresponding options. Then confirm the selected option and return back setup interface (refer to 6.4) by pressing ENTER button. Press ESC to cancel choice and return back setup interface (refer to 6.4). Default option is disability.</p>

6.4.4 Working parameters

Interface	Explanation
<pre> -- RUN SETTING-- →1: VPV-START 2: DELAY-START 3: VAC-MIN </pre>	<p>Press UP/DOWN button to move corresponding options, press ENTER to enter into the selected menu; return back setup interface (refer to 6.4) by pressing ESC, there are 10 options in total, including VPV-START, DELAY-START, VAC-MIN, VAC-MAX, FAC-MIN, FAC-MAX, ACTIVE POWER, REACT POWER, FREQ POWER and V LOAD.</p>

6.4.4.1 Starting-up voltage

Interface	Explanation
<pre> ---START-UP VOLT--- INPUT:200V UNIT: V </pre>	<p>Press UP/DOWN to increase or decrease the input figure, move the cursor backwards and confirm completion of input as well as enter into interface of please restart (refer to 6.4.4.11) by pressing ENTER button, press ESC to move the cursor forward and return back working interface (refer to 6.4.4); the input figure is 200, default is 200.</p>

6.4.4.2 Starting-up delay time

Interface	Explanation
<pre> -- START-UP DELAY-- INPUT: 60 UNIT: SEC </pre>	<p>Press UP/DOWN to increase or decrease the input figure, confirm input and enter into interface of please restart (refer to 6.4.4.11) by pressing ENTER button; press ESC to 4 cancel input and return back working interface (refer to 6.4.4), input figure is between 60 and 300. This parameter is changed by grid standards.</p>

6.4.4.3 Low voltage of electric network

Interface	Explanation
<pre> --GRID VOLT LOW-- INPUT: 450 UNIT: V </pre>	<p>Press UP/DOWN to increase or decrease the input figure, confirm input and enter into interface of please restart (refer to 6.4.4.11) by pressing ENTER button; press ESC to cancel input and return back working interface (refer to 6.4.4), input figure is between 450 and 490. This parameter is changed by grid standards.</p>

6.4.4.4 High voltage of electric network

Interface	Explanation
<pre> -- GRID VOLT HIGH -- INPUT:550 UNIT:V </pre>	<p>Press UP/DOWN to increase or decrease the input figure, confirm input and enter into interface of please restart (refer to 6.4.4.11) by pressing ENTER button; press ESC to cancel input and return back working interface (refer to 6.4.4), the input figure is between 510 and 550. This parameter is changed by grid standards.</p>

6.4.4.5 Low frequency of electric network

Interface	Explanation
<pre>-- GRID FREQ LOW-- INPUT: 49.5 UNIT: Hz</pre>	<p>Press UP/DOWN to increase or decrease the input figure, confirm input and enter into interface of please restart (refer to 6.4.4.11) by pressing ENTER button; press ESC to cancel input and return back working interface (refer to 6.4.4), the input figure is between 45.0 and 49.8. This parameter is changed by grid standards.</p>

6.4.4.6 High frequency of electric network

Interface	Explanation
<pre>-- GRID FREQ HIGH-- INPUT:50.5 UNIT:Hz</pre>	<p>Press UP/DOWN to increase or decrease the input figure, confirm input and enter into interface of please restart (refer to 6.4.4.11) by pressing ENTER button; press ESC to cancel input and return back working interface (refer to 6.4.4), the input figure is between 50.2 and 55. This parameter is changed by grid standards.</p>

6.4.4.7 Active power

Interface	Explanation
<pre>-- ACTIVE POWER -- -1:PERCENT SET 2:VALUE SET</pre>	<p>Press UP/DOWN to move corresponding options, and enter the selected menu by pressing ENTER button; press ESC button to return back working interface (refer to 6.4.4)</p>

6.4.4.7.1 Power limit

Interface	Explanation
<pre>----POWER LIMIT---- INPUT: 019 %</pre>	<p>Press UP/DOWN to increase or decrease the input figure, confirm input and enter into interface of Active power (refer to 6.4.4.7) by pressing ENTER button; press ESC to cancel input and return back Active power (refer to 6.4.4.7), the input figure is between 0 and 100,100% corresponds to 1.1 times of rated power output.</p>

6.4.4.7.2 Power Value

Interface	Explanation
<pre>-- POWER VALUE -- INPUT: KW</pre>	<p>Press UP/DOWN to increase or decrease the input figure, confirm input and enter into interface of Active power (refer to 6.4.4.7) by pressing ENTER button; press ESC to cancel input and return back Active power (refer to 6.4.4.7), the input figure is between 0 and Pmax.</p>

6.4.4.8 Reactive power

Interface	Explanation
<pre>-- RE-POWER SET -- -1:RE-POWER CTL 2:POWER FACTOR 3:PERCENT SET</pre>	<p>Press UP/DOWN to move corresponding options, and enter the selected menu by pressing ENTER button; press ESC button to return back working interface (refer to 6.4.4)</p>

6.4.4.8.1 RE-POWER CTL

Interface	Explanation
<pre>--RE-POWER CTL-- -1:POWER FACTOR 2:REACT POWER 3:QV WAVE</pre>	<p>Press UP/DOWN button to move corresponding options. And confirm selected option and return back the Reactive power by pressing ENTER button (refer to 6.4.4.8), press ESC button to cancel choice and return back Reactive power (refer to 6.4.4.8);</p>

6.4.4.8.2 Power factor

Interface	Explanation
<pre>--POWER FACTOR-- INPUT:0.000</pre>	<p>Press UP/DOWN to increase or decrease the input figure, confirm input and return back Reactive power (refer to 6.4.4.8) by pressing ENTER button, press ESC button to cancel input and return back Reactive power (refer to 6.4.4.8); The default value is 1, and the range can be set from 0.8 to 1.2, where 0.8 means lag 0.8 and 1.2 means lead 0.8.</p>

6.4.4.8.3 Reactive power

Interface	Explanation
<pre>-REACTIVE POWER- INPUT: -26%</pre>	Press UP/DOWN to increase or decrease the input figure, confirm input and return back Reactive power (refer to 6.4.4.8) by pressing ENTER button, press ESC button to cancel input and return back Reactive power (refer to 6.4.4.8); the input numerical value is between -60 and +60.

6.4.4.9 Over frequency derating

Interface	Explanation
<pre>----FREQ POWER---- →1:FUNC ENB 2:THRESHOLD</pre>	Press UP/DOWN button to move corresponding options, press ENTER to enter into the selected menu; return back working interface (refer to 6.4.4) by pressing ESC, there are 2 options in total, including function enable and frequency threshold.

6.4.4.9.1 Over frequency derating enable

Interface	Explanation
<pre>--FREQ POWER-- →1:ENABLE 2:DISABLE</pre>	Press UP/DOWN button to move corresponding options, press ENTER to enter into the Over frequency derating interface (refer to 6.4.4.9); return back Over frequency derating interface (refer to 6.4.4.9) by pressing ESC, there are 2 options in total, including enable and disable.

6.4.4.9.2 Frequency threshold

Interface	Explanation
<pre>----THRESHOLD---- INPUT: 65.0 UNIT: Hz</pre>	Press UP/DOWN to increase or decrease the input figure, confirm input and enter into interface of Over frequency derating interface (refer to 6.4.4.9) by pressing ENTER button; press ESC to cancel input and return back Over frequency derating interface (refer to 6.4.4.9).the input numerical value is between 50.2 and 65.0.

6.4.4.10 Over voltage derating

Interface	Explanation
<pre>--- V LOAD --- →1:ENABLE 2:DISABLE</pre>	Press UP/DOWN button to move corresponding options, press ENTER to enter into the working interface (refer to 6.4.4); return back working interface (refer to 6.4.4) by pressing ESC, there are 2 options in total, including enable and disable. Overvoltage threshold setting, 242 ~ 270V.

6.4.4.11 Please restart

Interface	Explanation
<pre>Please Restart!</pre>	A prompt that it is required to start the machine once again, so that the setup relevant to working will be effective, and it will return back working interface (refer to 6.4.4) within 2 seconds.

6.4.5 485 address

Interface	Explanation
<pre>---485 ADDRESS--- INPUT:1</pre>	Press UP/DOWN to increase or decrease the input figure, confirm input and return back setup interface (refer to 6.4) by pressing ENTER button, press ESC button to cancel input and return back setup interface (refer to 6.4); the input numerical value is between 1 and 64.

6.4.6 485 baudrate

Interface	Explanation
<pre>-----SELECT----- →1:2400 bps 2:4800 bps 3:9600 bps</pre>	Press UP/DOWN button to move corresponding options. And confirm selected option and return back the setup interface by pressing ENTER button (refer to 6.4), press ESC button to cancel choice and return back setup interface (refer to 6.4); options include 2400, 4800, 9600 and 19200, with 4 in total,Default is 9600.

6.4.7 485 protocol

Interface	Explanation
<pre>----SELECT---- →1: MODBUS 2:SOLAR RTU</pre>	Press UP/DOWN button to move corresponding options. And confirm selected option and return back the setup interface by pressing ENTER button (refer to 6.4), press ESC button to cancel choice and return back setup interface (refer to 6.4);

6.4.8 Display language

Interface	Explanation
<pre>---Display language--- →1:中文 2:ENGLISH 3:DEUTSCH</pre>	Press UP/DOWN button to move corresponding options. And confirm selected option and enter into the setup interface (refer to 6.4) by pressing ENTER button, press ESC button to cancel choice and return back setup interface (refer to 6.4).

6.4.9 LCD backlight

Interface	Explanation
<pre>---LIGHT TIME--- INPUT: 20 UNIT: SEC</pre>	Press UP/DOWN to increase or decrease the input figure, confirm input and return back setup interface (refer to 6.4) by pressing ENTER button, press ESC button to cancel input and return back setup interface (refer to 6.4); the input numerical value is between 20 and 120.

6.4.10 Date/time

Interface	Explanation
<pre>----DATE/TIME---- DATE:2000-01-01 TIME: 02:43:03 WEEK: 6</pre>	Press UP/DOWN to increase or decrease the input figure; press ENTER button to move the cursor backwards, confirm input and return back setup interface (refer to 6.4); and move the cursor forward and return back setup interface (refer to 6.4) by pressing ESC button.

6.4.11 History clearing

Interface	Explanation
<pre>--- DEL REC--- →1: CANCEL 2: CONFIRM</pre>	Clear all records in inquiry/record menu (refer to). Press UP/DOWN button to move corresponding options, and confirm the selected option and enter into setup interface (refer to 6.4) by pressing ENTER; press ESC button to cancel option and return back setup interface (refer to 6.4).

6.4.12 Password setting

Interface	Explanation
<pre>---- PASSWORD ---- OLD: XXXXX NEW: XXXXX CONFIRM: XXXXX</pre>	This interface will be used to alter password when entering into the setup interface (refer to 6.4). Press UP/ DOWN to increase or decrease the input figure, press ENTER button to move the cursor backwards, confirm input and return back setup interface (refer to 6.4); and move the cursor forward and return back setup interface (refer to 6.4) by pressing ESC button.

6.4.13 Maintenance

Interface	Explanation
<pre>----PASSWORD---- INPUT:XXXXX</pre>	This interface will be used for factory testing, and be protected by password.

6.4.14 Factory reset

Interface	Explanation
<pre>-FACTORY RESET- →1: CANCEL 2: CONFIRM</pre>	This interface will be used to reset inverter parameter to default. Press UP/DOWN button to move corresponding options, and confirm the selected option and enter into setup interface (refer to 6.4) by pressing ENTER; press ESC button to cancel option and return back setup interface (refer to 6.4).

6.4.15 Array detection

Interface	Explanation
<pre>- ARRAY DETECT - →1:DETECT ENB 2:THRESHOLD</pre>	Press UP/DOWN button to move corresponding options, and confirm the selected option and enter into setup interface (refer to 6.4) by pressing ENTER; press ESC button to cancel option and return back setup interface (refer to 6.4).

6.4.15.1 ARRAY

Interface	Explanation
<pre>--ARRAY-- 1:ENABLE →2:DISABLE</pre>	Press UP/DOWN button to move corresponding options. And confirm selected option and return back Array detection by pressing ENTER button (refer to 6.4.15), press ESC button to cancel choice and return back Array detection (refer to 6.4.15);

6.4.15.2 THRESHOLD

Interface	Explanation
<pre>--THRESHOLD-- INPUT:8A</pre>	Press UP/DOWN to increase or decrease the input figure, confirm input and return back Array detection (refer to 6.4.15) by pressing ENTER button, press ESC button to cancel input and return back Array detection (refer to 6.4.15); the input numerical value is between 5 and 25.

6.4.16 Three-phase system

Interface	Explanation
<pre>--Three-phase system-- 1:3W+N+PE →2:3W+PE</pre>	According to the actual wiring mode ; Press UP/DOWN button to move corresponding options, and confirm the selected option and enter into setup interface (refer to 6.4) by pressing ENTER; press ESC button to cancel option and return back setup interface (refer to 6.4).

6.5 Inquiry

Interface	Explanation
<pre>----INQUIRE---- →1: INV MODEL 2: MODEL NO 3: FIRMWARE 4: RECORD</pre>	Press UP/DOWN button to move the corresponding option, enter into the selected menu by pressing ENTER button; and return back the user interface (refer to 6.3) by pressing ESC button, there are 5 options in total, including INV MODEL, MODEL NO, FIRMWARE, RECORD And ERROR EVENT.

6.5.1 INV MODEL

Interface	Explanation
<pre>----INVERTER---- XXXXX</pre>	This interface displays product Model of the inverter. UP/DOWN button is invalid, ENTER button is invalid; and press ESC button to return back the inquiry interface (refer to 6.5).

6.5.2 MODEL SN

Interface	Explanation
<pre>----INVERTER---- SN:</pre>	This interface displays product series No. of the inverter. UP/DOWN button is invalid, ENTER button is invalid; and press ESC button to return back the inquiry interface (refer to 6.5).

6.5.3 Firmware

Interface	Explanation
<pre>----FIRMWARE---- ARM VER: I-DSP VER: B-DSP VER:</pre>	This interface displays edition No. of firmware such as ARM and DSP in inverter. UP/DOWN button is invalid, ENTER button is invalid; and press ESC button to return back the inquiry interface (refer to 6.5).

6.5.4 RECORD

Interface	Explanation
<pre>----REC(35)---- 1:F01-1 DATE: 2011-10-21 TIME: 16:35:26</pre>	This interface displays record and its occurring time, including two types of fault and warning alarm, its content will be described in codes, with total number of 500 at utmost, after exceeding this extent, the one with earliest time will be covered. Press UP/DOWN button to look over record backwards or frontward, and press ENTER to enter into explanation interface for corresponding record content, as shown in the following Figure. Press ESC to return back inquiry interface (refer to 6.5).

<pre>----DETAIL---- Grid voltage High</pre>	This interface will be used to reset inverter parameter to default. Press UP/DOWN button to move corresponding options, and confirm the selected option and enter into setup interface (refer to 6.4) by pressing ENTER; press ESC button to cancel option and return back setup interface (refer to 6.4).
---	--

<pre>--- VALUE--- 285V</pre>	This interface is used for displaying the corresponding specific numerical value when the code generates. For example, producing error code for high voltage value of commercial power, and we can refer to the voltage value of cat that that in this interface. Some codes correspond no numerical values, and then these interfaces are blank. If the voltage value is 999.9, it means that the voltage and current of the power grid have a shock protection. UP/ DOWN button is invalid, and ENTER is also invalid; press ESC button to return back the last interface.
------------------------------	--

6.5.5 ERROR EVENT

Interface	Explanation
<pre>----EVE(20)---- 1:F01-1 Date: 2011-10-21 Time: 16:35:26</pre>	Press UP/DOWN button to look over record backwards or frontward, and press ENTER to enter into explanation interface for corresponding record content, as shown in the following Figure. Press ESC to return back inquiry interface (refer to 6.5).
<pre>--EVE(1)-- +BUS: 350.0V -BUS: 350.0V RADIATOR: 50°C</pre>	Press UP/DOWN button to look over record backwards or frontward, press ESC button to return back the last interface.

```
--EVE(1)--
RS: 0.00Hz
ST: 0.00Hz
TR: 0.00Hz
```

Press UP/DOWN button to look over record backwards or forward, press ESC button to return back the last interface.

```
--EVE(1)--
RS: 0.00V
ST: 0.00V
TR: 0.00V
```

Press UP/DOWN button to look over record backwards or forward, press ESC button to return back the last interface.

6.6 Statistics

Interface	Explanation
<pre>----- STAT. ----- →1:TIME STAT. 2:CONNE.TIMES 3:PEAK POWER</pre>	<p>This interface is used to select various options for statistics. UP/DOWN button is used to move corresponding options, press ENTER button to enter the selected menu; and press ESC to return back the user interface (refer to 6.3), there are 8 options, including time, networking number, total, that day, that week, that month, that year, power peak.</p>

6.6.1 Time statistics

Interface	Explanation
<pre>-----TIME----- RUN: 86 GRID: 56 UNIT: HOUR</pre>	<p>This interface displays operational time and generating duration of the inverter. UP/DOWN button is invalid, and ENTER is also invalid; press ESC button to return back statistics interface (refer to 6.6).</p>

6.6.2 Times of paralleling in

Interface	Explanation
<pre>--CONNE.TIMES-- TIMES: 45</pre>	<p>This interface displays times of paralleling in for the inverter. UP/DOWN button is invalid, and ENTER is also invalid; press ESC button to return back statistics interface (refer to 6.6).</p>

6.6.3 Power peak

Interface	Explanation
<pre>-----PEAK POWER----- HISTORY:10645 TODAY: 9600 UNIT: W</pre>	<p>This interface displays history power peak and today power peak of the inverter. UP/DOWN button is invalid, and ENTER is also invalid; press ESC button to return back statistics interface (refer to 6.6).</p>

6.6.4 Generated energy of that day

Interface	Explanation
<pre>-----E-TODAY----- NUM: 100 UNIT: KWH</pre>	<p>This interface displays generated energy of that day. Refresh after 24 o'clock, inverter time should be set in different time zones. UP/DOWN button is invalid, and ENTER is also invalid; press ESC button to return back statistics interface (refer to 6.6).</p>

6.6.5 Generated energy of that week

Interface	Explanation
<pre>-----E-WEEK----- NUM: 700 UNIT: KWH</pre>	<p>This interface displays generated energy of that day. UP/DOWN button is invalid, and ENTER is also invalid; press ESC button to return back statistics interface (refer to 6.6).</p>

6.6.6 Generated energy of that month

Interface	Explanation
<pre>-----E-MONTH----- NUM: 3000 UNIT: KWH</pre>	<p>This interface displays generated energy of that month. UP/DOWN button is invalid, and ENTER is also invalid; press ESC button to return back statistics interface (refer to 6.6).</p>

6.6.7 Generated energy of that year

Interface	Explanation
<pre>-----E-YEAR----- NUM: 30000 UNIT: KWH</pre>	<p>This interface displays generated energy of that year. UP/DOWN button is invalid, and ENTER is also invalid; press ESC button to return back statistics interface (refer to 6.6).</p>

6.6.8 Gross generation

Interface	Explanation
<pre>-----E-TOTAL----- NUM: 100000 UNIT: KWH</pre>	<p>This interface displays gross generation of the inverter. UP/DOWN button is invalid, and ENTER is also invalid; press ESC button to return back statistics interface (refer to 6.6).</p>

07 Maintenance

Inverter does not require any regular maintenance. However, cleaning the dust on heat-sink will help the inverter to dissipate the heat and increase its life time. The dust can be removed with a soft brush.



CAUTION:

Do not touch the inverter's surface when it is operating. Some parts of the inverter may be hot and cause burns. Turn off the inverter and wait for a cool-down period before any maintenance or cleaning operation.



NOTE:

Never use any solvents, abrasives or corrosive materials to clean the inverter.

Fan Maintenance



DANGER:

- Stop the inverter and disconnect it from all power supplies before maintenance.
- Lethal voltage still exists in the inverter. Please wait for at least 5 minutes and then perform maintenance work.
- Only qualified electricians can maintain the fans.

Fans inside the inverter are used to cool the inverter during operation. If the fans do not operate normally, the inverter may not be cooled down and inverter efficiency may decrease. Therefore, it is necessary to clean the dirty fans and replace the broken fans in time. The operation procedure is as follows:

- Step 1: Stop the inverter;
- Step 2: Unscrew the hand screw at the bottom of the fan side decoration and push down the decoration to complete the removal of the decoration;
- Step 3: Press the hump of the latch hook, unplug the cable connection joint outwards;
- Step 4: Pull out the fan module, clean the fans with soft brush or vacuum cleaner, and replace them when necessary;
- Step 5: Reinstall the fan back to the inverter in reverse order and restart the inverter.

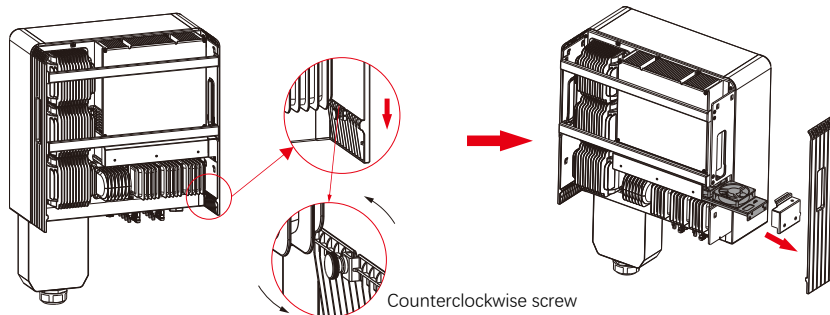

08 Trouble shooting

It is very easy for the inverter's maintenance. When you meet any problems, please refer to the following trouble shooting first, please contact your local distributor if the problem can't be solved by yourself.

The following sheet lists some basic questions may encounter in the operation.

Alarm Message	Failure description	Solution
F00-F03	AC voltage & frequency are too high or too low.	<ol style="list-style-type: none"> 1. Please check mains voltage whether it is complied with local safety standard 2. Please check the AC output line is properly connected. Make sure its output voltage to see if it is normal. 3. Disconnect PV input and restart the inverter and check whether. 4. If the power grid is normal, the fault is still reported. Please contact the dealer.
F04-F05	Bus voltage is too high or too low.	<ol style="list-style-type: none"> 1. Please check the setting of input mode 2. Disconnect PV input and restart the inverter and check whether fault still exists, Please contact the dealer.
F06	Bus voltage is Unbalance	<ol style="list-style-type: none"> 1. Please check the setting of input mode. 2. Disconnect PV input and restart the inverter and check whether fault still exists. 3. The fault still exists after the restart. Please contact the dealer.
F07	Insulation impedance Fault	<ol style="list-style-type: none"> 1. Disconnect PV input and restart the inverter and check whether fault still exists. 2. Please measure impedance of PV+/PV- to ground whether is over than 50KΩ. 3. The insulation of the series is normal but the fault still exists. Please contact the dealer.
F08	Input Current High	<ol style="list-style-type: none"> 1. Please check the setting of input mode. 2. Disconnect PV input and restart the inverter and check whether fault still exists.
F09	Hardware Current High	<ol style="list-style-type: none"> 1. Disconnect PV input and restart the inverter after few minutes and check whether fault still exists.
F10	Inverter Current High	<ol style="list-style-type: none"> 1. Disconnect PV input and restart the inverter after few minutes and check whether fault still exists.

Alarm Message	Failure description	Solution
F11	Inverter DC Current high	1.Disconnect PV input and restart the inverter after few minutes and check whether fault still exists.
F12	Amb Temperature Over	1.Disconnect PV input and cool down the inverter then restart the inverter to see if it is back to normal operation. 2.Please check environmental temperature whether out of working temperature.
F13	Heatsink Temperature High	1.Disconnect PV input and cool down the inverter then restart the inverter to see if it is back to normal operation. 2.Please check environmental temperature whether out of working temperature.
F14	AC Relay Fault	1.Disconnect PV input and restart the inverter and check whether fault still exists. 2. Check whether the phase line is missing phase, such as R, S, T phase.
F15	PV Input Voltage Low	1.Please check the configuration of PV input, one of PV input is idle when inverter is set on parallel mode. 2.Disconnect the PV input and restart the inverter and check whether fault still exists.
F16	Remote Off	1.The inverter is on remote OFF status, the Inverter can be turned,off/on remotely by monitoring software.
F18	SPI communication Fault	1.Disconnect PV input and restart the inverter and check whether fault still exists.
F20	Leakage Current High	1.Disconnect PV input and restart the inverter and check whether fault still exists. 2. Check whether the AC cable and PV input line have abnormal insulation.
F21	Leakage Current Self-Checking Failure	1.Disconnect PV input and restart the inverter and check whether fault still exists. 2.Contact with your local distributor if the fault still exists.
F22	Consistency Voltage Fault	1.Disconnect PV input and restart the inverter and check whether fault still exists. 2.Contact with your local distributor if the fault still exists.

Alarm Message	Failure description	Solution
F23	Consistency Frequency Fault	1.Disconnect PV input and restart the inverter and check whether fault still exists. 2.Contact with your local distributor if the fault still exists.
F24	Isolated island Fault	1.Disconnect PV input and restart the inverter and check whether fault still exists. 2.Contact with your local distributor if the fault still exists.
F26	IGBT Fault	1.Disconnect PV input and restart the inverter and check whether fault still exists. 2.Contact with your local distributor if the fault still exists.
F27	N line-to-earth voltage is high	1. Check whether the ground of the machine is connected to the ground of the power grid. 2. Check whether the voltage of line n to the ground is higher than the protection value.
F32	DSP communication Lost	1.Disconnect PV input and restart the inverter and check whether fault still exists. 2.Contact with your local distributor if the fault still exists.

▲ Table 8.1 Trouble shooting

**NOTE:**

If the inverter displays any alarm message as listed in Table 8.1; please turn off the inverter (refer to Section 5.2 to stop your inverter) and wait for 5 minutes before restarting it (refer to Section 5.1 to start your inverter). If the failure persists, please contact your local distributor or the service center. Please keep ready with you the following information before contacting us.

1. Serial number of Inverter;
2. The distributor/dealer of Inverter (if available);
3. Installation date.
4. The description of problem (i.e. the alarm message displayed on the LCD and the status of the LED status indicator lights. Other readings obtained from the Information submenu will also be helpful.) ;
5. The PV array configuration (e.g. number of panels, capacity of panels, number of strings ,etc.);
6. Your contact details.

09 Specifications

Model Specifications	G40KT6
Input(DC)	
Max. DC voltage	1100V
Max. input current per MPPT tracker	32/32/20/20A
PV short circuit current	50/50/30/30A
PV Backfeed Current	0A _{dc}
Start voltage	250V
MPPT voltage range	200-1000V
Full load MPPT voltage range	550-850 @32A,500-850 @26A
Nominal voltage	650V
Max. number of inputs	6
Number of MPPT trackers	4
Strings per MPPT tracker	2/2/1/1
Output(AC)	
Normal AC output power	40kW
Max. apparent power	44kVA
Max. AC output power	44kW
Normal AC voltage	230/400V,3W+N+PE/3W+PE
Normal AC grid frequency	50Hz/60Hz
Nominal output current	57.7A
Max. output current	66.7A
Power factor(Φ)	-0.8~+0.8
THDi	3%
Efficiency	
Max. efficiency	98.6%
Euro efficiency	98.1%
General Specifications	
Dimensions (W / L / D)	548*540*289mm
Weight(KG)	38kg
Operating temperature range	-25°C ~ +60°C
Cooling type	
	Fan Cooling
Max. operation altitude	4000m (> 3000m derating)
Max. operation humidity	0~100%
IP class	IP66
Topology	Transformer-less
Pollution degree	External:PD3 Internal:PD2
Safety	
	Class I
Display and communication	
Display	LCD/LED
Communication	RS485/WIFI/GPRS

09 Specifications

Model Specifications	G50KT6
Input(DC)	
Max. DC voltage	1100V
Max. input current per MPPT tracker	40/40/32/32A
PV short circuit current	60/60/50/50A
PV Back feed Current	0A _{dc}
Start voltage	250V
MPPT voltage range	200-1000V
Full load MPPT voltage range	550-850 @40A,500-850 @26A
Nominal voltage	650V
Max. number of inputs	8
Number of MPPT trackers	4
Strings per MPPT tracker	2
Output(AC)	
Normal AC output power	50kW
Max. apparent power	55kVA
Max. AC output power	55kW
Normal AC voltage	230/400V,3W+N+PE/3W+PE
Normal AC grid frequency	50Hz/60Hz
Nominal output current	72.2A
Max. output current	83.3A
Power factor(Φ)	-0.8~+0.8
THDi	3%
Efficiency	
Max. efficiency	98.5%
Euro efficiency	98.0%
General Specifications	
Dimensions (W / L / D)	548*540*289mm
Weight(KG)	39kg
Operating temperature range	-25°C ~ +60°C
Cooling type	
	Fan Cooling
Max. operation altitude	4000m (> 3000m derating)
Max. operation humidity	0~100%
IP class	IP66
Topology	Transformer-less
Pollution degree	External:PD3 Internal:PD2
Safety	
	Class I
Display and communication	
Display	LCD/LED
Communication	RS485/WIFI/GPRS

09 Specifications

Model Specifications		G60KT6
Input(DC)		
Max. DC voltage		
Max. input current per MPPT tracker		40/40/32/32A
PV short circuit current		60/60/48/48A
PV Backfeed Current		0A _{dc}
Start voltage		250V
MPPT voltage range		200-1000V
Full load MPPT voltage range		550-850 @40A
Nominal voltage		650V
Max. number of inputs		8
Number of MPPT trackers		4
Strings per MPPT tracker		2
Output(AC)		
Normal AC output power		60kW
Max. apparent power		66kVA
Max. AC output power		66kW
Normal AC voltage		230/400V,3W+N+PE/3W+PE
Normal AC grid frequency		50Hz/60Hz
Nominal output current		86.6A
Max. output current		100A
Power factor(Φ)		-0.8~+0.8
THDi		3%
Efficiency		
Max. efficiency		98.5%
Euro efficiency		98.0%
General Specifications		
Dimensions (W / L / D)		548*540*289mm
Weight(KG)		39.8kg
Operating temperature range		-25°C ~ +60°C
Cooling type		Fan Cooling
Max. operation altitude		4000m (> 3000m derating)
Max. operation humidity		0~100%
IP class		IP66
Topology		Transformer-less
Pollution degree		External:PD3 Internal:PD2
Safety		Class I
Display and communication		
Display		LCD/LED
Communication		RS485/WIFI/GPRS

09 Specifications

Protection devices	
DC Switch	Yes
Output over current	Yes
Anti-islanding protection	Yes
DC reverse polarity protection	Yes
String fault detection	Optional
AC/DC surge protection	DC: Type II / AC: Type III / Type II Optional
Insulation detection	Yes
AC short circuit protection	Yes
Other functions	
Anti-reflux	Support, need to select distribution table
PID recovery	Optional
IV scan	/
Remote upgrade	Yes
Authentication	
Safety regulations	"EN/IEC 62109-1_2010 ; EN/IEC 62109-2_2011"
EMC	EN/IEC 61000-6-1/2/3/4 ; EN/IEC 61000-3-11/12
performance	IEC 60068 ; IEC 60529 ; IEC62116 ; IEC61727
Grid standards	NB32004-2018,EN50549-1,VDE-AR-N-4105-2018 VDE0124,VDE0126,CEI 0-21,C10/C11,G98/G99

Table 9.1 Grid Specification(3W+N+PE)

Grid Specification	Output Voltage Range (Vac)	Output Frequency Range (Hz)	Boot wait time(S)	Error recovery time (S)
China	195.5 - 276	48 - 50.5	60	30
Germany	184 - 287.5	47.5 - 51.5	60	30
Australia	200 - 270	48 - 52	60	30
Italy	195.5 - 264.5	47.5 - 51.5	60	30
Spain	196 - 253	48 - 52	180	30
U.K.	184 - 262.2	47.5 - 52	180	30
Hungary	196 - 253	49 - 51	300	30
Belgium	184 - 264.5	47.5 - 51.5	60	30
AUS-W	200 - 270	47.5 - 50.5	60	30
Greece	184 - 264	49.5 - 50.5	180	30
France	184 - 264.5	47.5 - 51.5	60	30
Metro	176 - 264	49 - 51	60	30
Thailand	176 - 264	47 - 52	60	30
GB19964	184 - 253	48.5 - 50.5	60	30
Local	184 - 290	48 - 52	60	30
60Hz	184 - 276	58 - 62	60	30
LV50Hz	98 - 150	47.5 - 52.5	60	30
LV60Hz	60 - 190	55 - 65	60	30
50549(Europe)	115 - 276	47 - 52	60	30
LV50549	115 - 276	46.5 - 52.5	60	30
South Africa	195.5 - 253	47 - 52	60	30
India	196 - 265	48.5 - 51.5	60	30
Poland	195.5 - 253	47.5 - 52	60	30
Brazil	176 - 242	57.5 - 62	60	30
Ireland	191 - 269	47 - 52	60	30
Denmark	195.5 - 253	47.5 - 51.5	60	30
Austria	184 - 264.5	47.5 - 51.5	60	30

Table 9.2 Grid Specification(3W+PE/LL)

Grid Specification	Output Voltage Range (Vac)	Output Frequency Range (Hz)	Boot wait time(S)	Error recovery time (S)
China	340 - 480	48 - 50.5	60	30
Germany	320 - 500	47.5 - 51.5	60	30
Australia	340 - 480	48 - 52	60	30
Italy	340 - 460	47.5 - 51.5	60	30
Spain	340 - 440	48 - 52	180	30
U.K.	320 - 456	47.5 - 52	180	30
Hungary	360 - 440	49 - 51	300	30
Belgium	320 - 460	47.5 - 51.5	60	30
AUS-W	340 - 480	47.5 - 50.5	60	30
Greece	320 - 460	49.5 - 50.5	180	30
France	315 - 460	47.5 - 51.5	60	30
Metro	320 - 480	49 - 51	60	30
Thailand	320 - 480	47 - 52	60	30
GB19964	346 - 438	48.5 - 50.5	60	30
Local	320 - 502	48 - 52	60	30
60Hz	320 - 480	58 - 62	60	30
LV50Hz	98 - 150	47.5 - 52.5	60	30
LV60Hz	110 - 330	55 - 65	60	30
50549(Europe)	200 - 480	47 - 52	60	30
LV50549	115 - 276	46.5 - 52.5	60	30
South Africa	340 - 440	47 - 52	60	30
India	340 - 460	48.5 - 51.5	60	30
Poland	340 - 440	47.5 - 52	60	30
Brazil	304 - 418	57.5 - 62	60	30
Ireland	332 - 468	47 - 52	60	30
Denmark	323 - 418	47.5 - 51.5	60	30
Austria	318.7 - 442.2	47.5 - 51.5	60	30

10 Quality Assurance

When product faults occur during the warranty period, KSTAR or his partner will provide free service or replace the product with a new one.

Evidence

During the warranty period, the customer shall provide the product purchase invoice and date. In addition, the trademark on the product shall be undamaged and legible. Otherwise, KSTAR has the right to refuse to honor the quality guarantee.

Conditions

- After replacement, unqualified products shall be processed by KSTAR.
- The customer shall give KSTAR or his partner a reasonable period to repair the faulty device.

Exclusion of Liability

In the following circumstances, KSTAR has the right to refuse to honor the quality guarantee:

- The free warranty period for the whole machine/components has expired.
- The device is damaged during transport.
- The device is incorrectly installed, refitted, or used.
- The device operates in harsh environment, as described in this manual.
- The fault or damage is caused by installation, repairs, modification, or disassembly performed by a service provider or personnel not from KSTAR or his authorized partner.
- The fault or damage is caused by the use of non-standard or non-KSTAR.

Components or software.

- The installation and use range are beyond stipulations of relevant international standards.
- The damage is caused by unexpected natural factors.

For faulty products in any of above cases, if the customer requests maintenance, paid maintenance service may be provided based on the judgment of KSTAR.

11 Contact Information

18 overseas branch offices



☎ PV inverter industry Pre-sales : (86)0755-89741234 Ext 8151

☎ PV inverter industry After-sales : (86)0755-89741234 Ext 8729

✉ Global overseas service mailbox : overseas_service@kstar.com.cn